

T6 Recessed Fluorescent Range

■ RFC	p30
■ REC	p31
■ REIP	p32
■ IDC	p33
■ IDL	p34
■ IDD	p35
■ RFT	p36
■ RLG	p37
■ RLW	p38
■ RCC	p39
■ RWW	p40

T6

Recessed
Fluorescent Range

CODE: RFC

DESCRIPTION

Standard T-grid modular fitting c/w HF gear and CAT2 louvre.

Available Version:

4x14W T5 4x18W T8

4x28W T5 2x36W T8

Emergency version available

SPECIFICATION

- White powder coated metal body
- Specular wedge blade louvre
- Suitable for installation in 25mm exposed T-grid ceiling

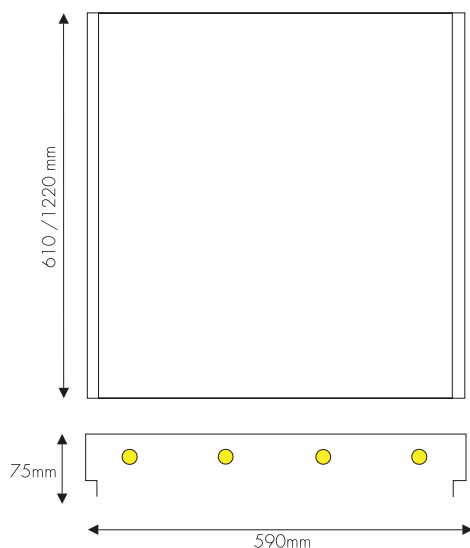
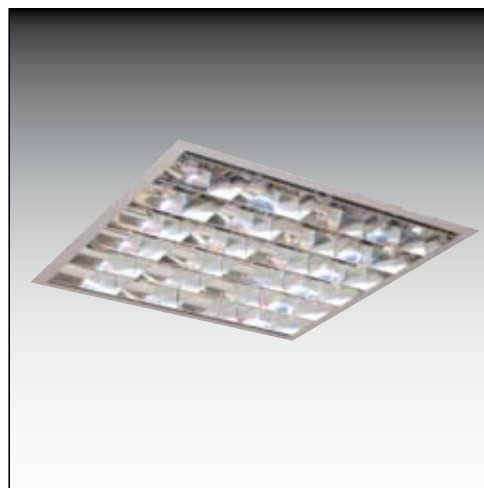

Fully wired	Less lamps	
T6RFC418FZ	4 x 18w HF gear	600MM x 600MM
T6RFC436FZ	4 x 36w HF gear	1200MM x 600MM
T6RFC414FZ	4 x 14w HF gear	
T6RFC428FZ	4 x 28w HF gear	

CODE: **REC**

DESCRIPTION

Designed for compatibility with today's commercial interiors with specular wedge CAT2 louvre.

Available Version:

4x18W T8

2x36W T8

Emergency version available

SPECIFICATION

- White powder coated metal body
- Specular wedge blade louvre
- Suitable for installation in 15mm/25mm exposed T-grid ceiling and plasterboard
- 4x sidearm support brackets per fitting

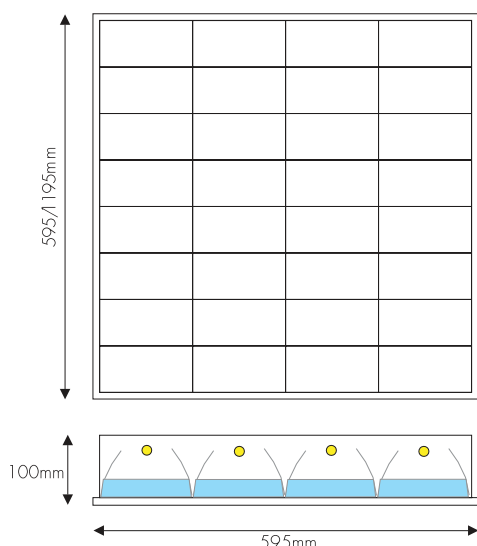

Fully wired	Less lamps	
T6REC418FZ	4 x 18w HF gear	600MM x 600MM
T6REC436FZ	4 x 36w HF gear	1200MM x 600MM

T6

Recessed
Fluorescent Range

CODE: REIP

DESCRIPTION

A range of clear room luminaires incorporating welded frame assembly for durability. Sealed frames give IP54 protection.

Available Version:

3x 14w T5 4x 14w T5

3x 24w T5 4x 24w T5

3x 18w T8 4x 18w T8

3x 36w T8 4x 36w T8

Emergency version available

SPECIFICATION

- White powder coated metal body
- Suitable for installation in 15mm/25mm exposed T-grid ceiling and plasterboard
- Prismatic polycarbonate TP(a) rated panel as standard
- IP54 protection to lit space

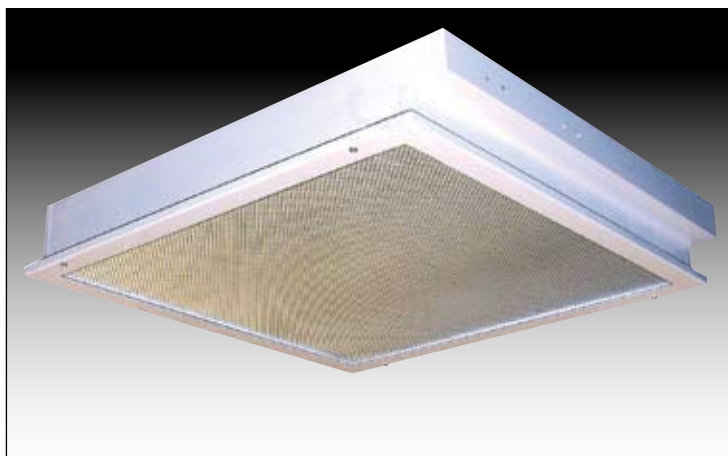
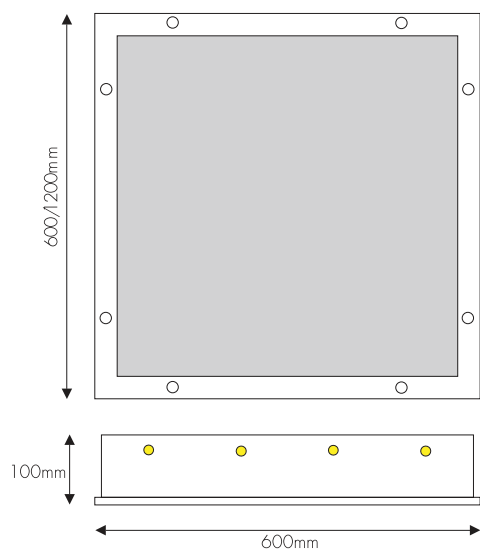

T8 High Frequency		T5 High Frequency	
T6REIP418FZ	4x18w T8 HF Gear	T6REIP314FZ	3x14w T5 HF Gear
T6REIP436FZ	4x36w T8 HF Gear	T6REIP414FZ	4x14w T5 HF Gear
T6REIP318FZ	3x18w T8 HF Gear	T6REIP324FZ	3x24w T5 HF Gear
T6REIP336FZ	3x36w T8 HF Gear	T6REIP424FZ	4x24w T5 HF Gear

CODE: IDC

DESCRIPTION

Designed for compatibility with today's commercial interiors. The specular wedge blade louvre and white gull-wing reflector harness a combination of direct and indirect light to produce an efficient optical system.

Available Version:

1x36w PL 2x36w PL
1x40w PL 2x40w PL
1x55w PL 2x55w PL
Emergency version available

SPECIFICATION

- White powder coated metal body
- Specular wedge blade louvre
- Suitable for installation in 15mm/25mm exposed T-grid ceiling
- Perforated curved louvre with an opal inner lining for diffuse illumination

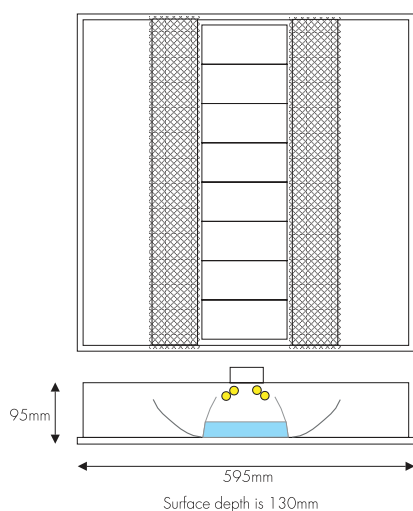

High Frequency

T6IDC136PZ	1x36w HF Gear	Available As 500mm x 500mm
T6IDC140PZ	1x40w HF Gear	
T6IDC155PZ	1x55w HF Gear	
T6IDC236PZ	2x36w HF Gear	Available As 500mm x 500mm
T6IDC240PZ	2x40w HF Gear	
T6IDC255PZ	2x55w HF Gear	
Plasterboard Recessing Kit - ATT 01 IDC		

T6

Recessed
Fluorescent Range

CODE: IDL

DESCRIPTION

Designed for compatibility with today's commercial interiors, with a micro perforated basket reflector harnesses a combination of direct/indirect light to produce an efficient optical system.

Available Version:

1x36w PLL 2x36w PLL

1x40w PLL 2x40w PLL

1x55w PLL 2x55w PLL

Emergency version available

SPECIFICATION

- White powder coated metal body
- Suitable for installation in 15mm/25mm exposed T-grid ceiling
- Perforated curved louvre with an opal inner lining for diffuse illumination

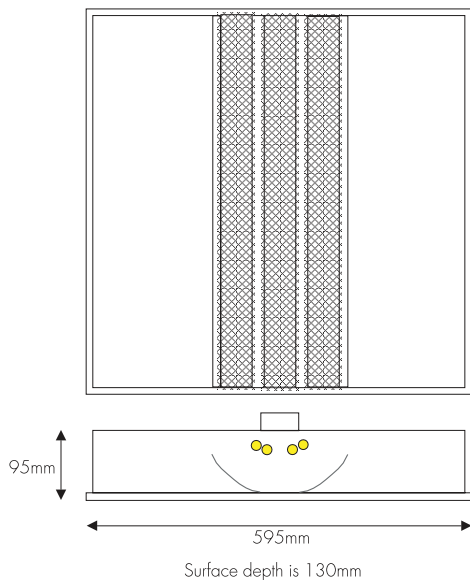
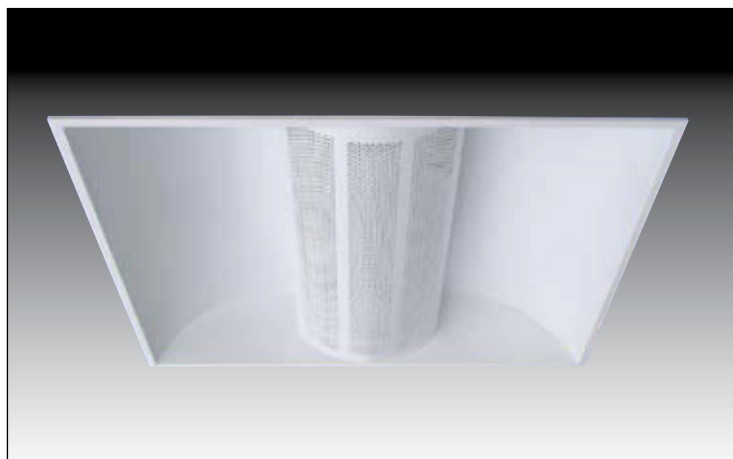

High Frequency

T6IDL136PZ	1x36w HF Gear	Available As 500mm x 500mm
T6IDL140PZ	1x40w HF Gear	
T6IDL155PZ	1x55w HF Gear	
T6IDL236PZ	2x36w HF Gear	Available As 500mm x 500mm
T6IDL240PZ	2x40w HF Gear	
T6IDL255PZ	2x55w HF Gear	

CODE: **IDD**

DESCRIPTION

Designed for compatibility with today's commercial interiors, with a micro perforated basket reflector harnesses a combination of direct/indirect light to produce an efficient optical system.

Available Version:

1x36w PLL 2x36w PLL

1x40w PLL 2x40w PLL

1x55w PLL 2x55w PLL

Emergency version available

SPECIFICATION

- White powder coated metal body
- Suitable for installation in 15mm/25mm exposed T-grid ceiling
- Perforated curved louvre with an opal inner lining for diffuse illumination

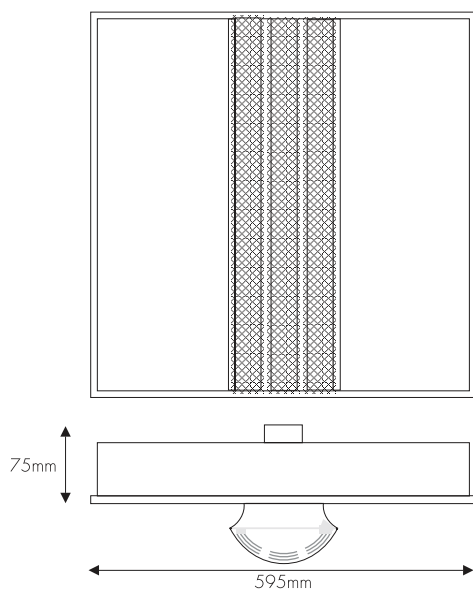

High Frequency

T6IDD136PZ	1x36w HF Gear	Available As 500mm x 500mm
T6IDD140PZ	1x40w HF Gear	
T6IDD155PZ	1x55w HF Gear	
T6IDD236PZ	2x36w HF Gear	Available As 500mm x 500mm
T6IDD240PZ	2x40w HF Gear	
T6IDD255PZ	2x55w HF Gear	

T6

Recessed
Fluorescent Range

CODE: RFT

DESCRIPTION

Designed for compatibility with today's commercial interiors. The specular wedge blade louvre and perforated panels in this slimline recessed luminaire produce an efficient optical system.

Available Version:

3x14w (T5)

3x24w (T5)

4x14w (T5)

4x24w (T5)

Emergency version available

SPECIFICATION

- White powder coated metal body
- Specular wedge blade louvre
- Suitable for installation in 15mm / 25mm exposed T-grid ceiling
- Perforated infill panels in between lamps

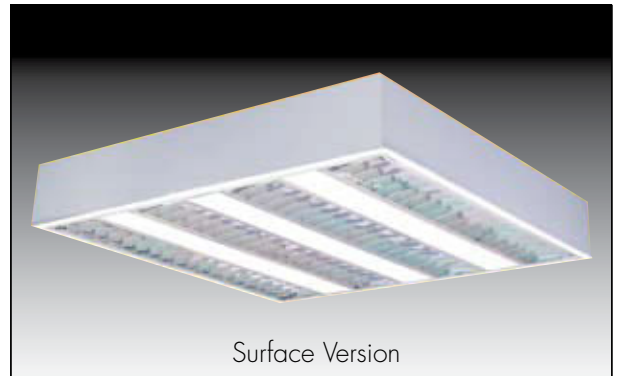
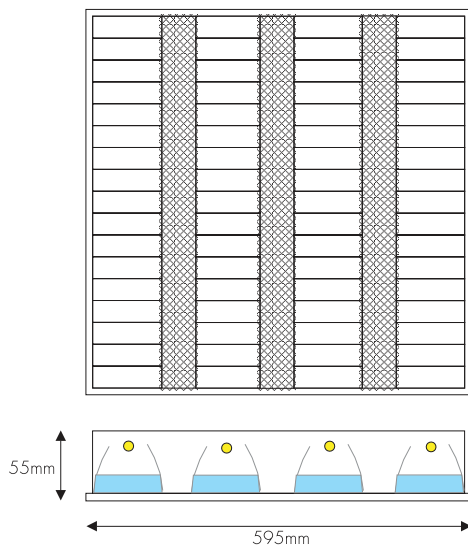

High Frequency

T6RFT314FZ	3x14w HF Gear
T6RFT414FZ	4x14w HF Gear
T6RFT324FZ	3x24w HF Gear
T6RFT424FZ	4x24w HF Gear

CODE: **RLG**

DESCRIPTION

Designed for compatibility with today's LG7 requirement. Where recessing depth is minimal. Combination of upward and downward light to produce an efficient optical system.

Available Version:

3x14w (T5)

3x24w (T5)

4x14w (T5)

4x24w (T5)

Emergency version available

SPECIFICATION

- White powder coated metal body
- Specular wedge blade louvre
- Suitable for installation in 15mm/25mm exposed T-grid ceiling
- Perforated infill panels in between lamps
- Patent sidekick refractor allows light spill on the surface of the luminaire

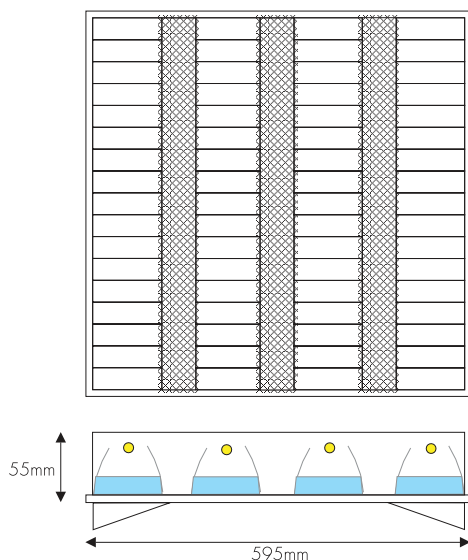
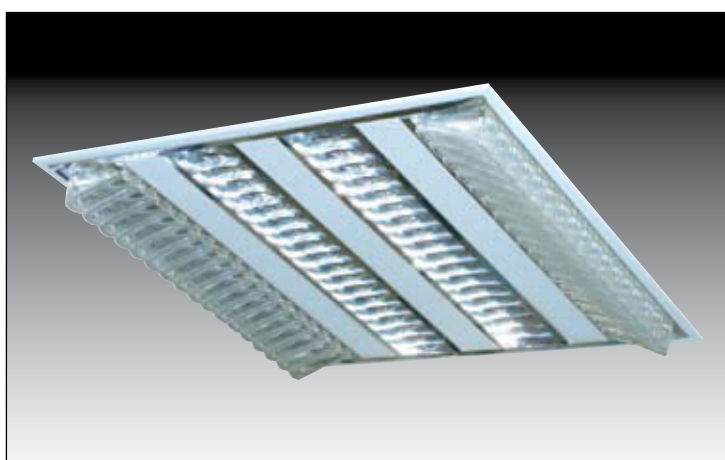

High Frequency

T6RLG314FZ	3x14w HF Gear
T6RLG414FZ	4x14w HF Gear
T6RLG324FZ	3x24w HF Gear
T6RLG424FZ	4x24w HF Gear

T6

Recessed
Fluorescent Range

CODE: RLW

DESCRIPTION

Designed for compatibility with today's LG7 requirement. Where recessing depth is minimal. Combination of upward and downlight to produce an efficient optical system.

Available Version:

4x14w (T5)

4x24w (T5)

Emergency version available

SPECIFICATION

- White powder coated metal body
- Specular wedge blade louvre
- Suitable for installation in 15mm/25mm exposed T-grid ceiling

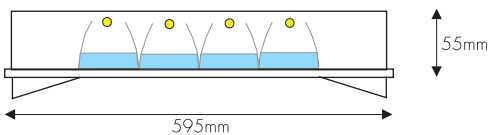
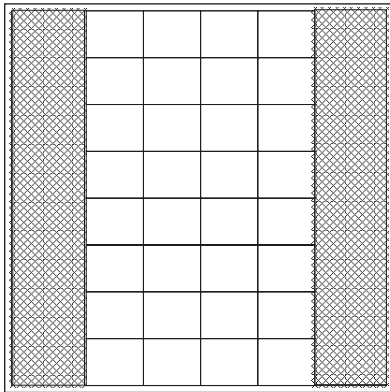
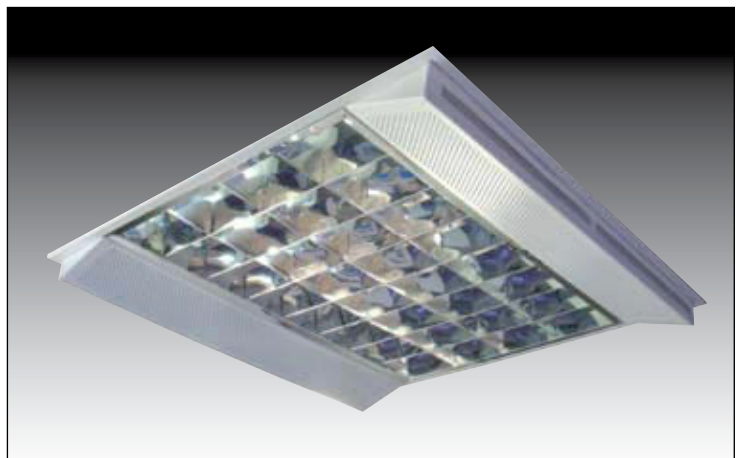

High Frequency

Fully wired less lamps

T6RLW414FZ

4x14w HF Gear

T6RLW424FZ

4x24w HF Gear

T6

Recessed
FluorescentRange

CODE: RCC

DESCRIPTION

The combination recessed luminaire is aimed to facilitate diverse lighting design with its use of a specular wedge blade louvre and adjustable heads. This product offered with the option of 2 or 4 of these heads, each of which are suitable for AR111 or CDM-T lamps.

Available Version:

2-head version

2x55w PLL + 2x75w AR111

2x55w PLL + 2x70w CDM-T

2x55w PLL + 2x150w CDM-T

4-head version

2x55w PLL + 4x75 AR111

2x55w PLL + 4x70 CDM-T

2x55w PLL + 4x150 CDM-T

SPECIFICATION

- Energy efficient, high frequency electronic control gear for visual comfort
- Suitable for installation in 15mm/25mm exposed T-grid ceiling
- Slimline body for easy installation with minimal recessing depth

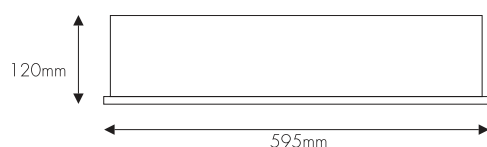

2- headed version

T6RCC255275 2x55w PLL + 2x75x AR111

T6RCC255270 2x55w PLL + 2x70w CDM-T

T6RCC2552150 2x55w PLL + 2x150w CDM-T

4-head version

T6RCC2552475 2x55w PLL + 4x75 AR111

T6RCC2552470 2x55w PLL + 4x70 CDM-T

T6RCC25524150 2x55w PLL + 4x150 CDM-T

T6

Recessed
Fluorescent Range

CODE: RWW

DESCRIPTION

Recessed mounted wall washer with a combination of high performance and excellent luminance uniformity.

Available Version:

1x40w TCL 2x40w TCL
 1x55w TCL 2x55w TCL
 1x24w T5
 1x54w T5

SPECIFICATION

- Suitable for plasterboard and suspended ceiling
- High vertical illuminance
- Low glare

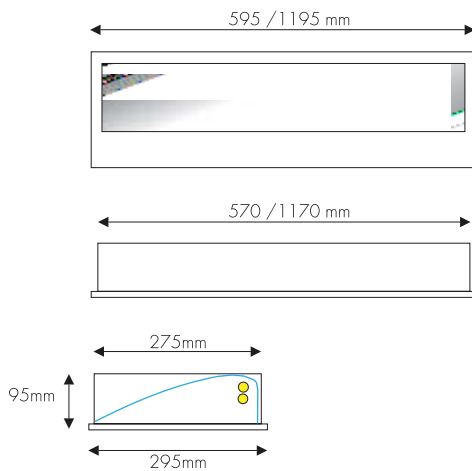

High Frequency	
Fully wired	Less lamps
T6RWW140PZ	1x40w PLL HF Gear
T6RWW240PZ	2x40w PLL HF Gear
T6RWW155PZ	1x55w PLL HF Gear
T6RWW255PZ	2x55w PLL HF Gear
T6RWW124FZ	1x24w T5 HF Gear
T6RWW154FZ	1x54w T5 HF Gear

T6
Recessed
Fluorescent Range

CODE: **OPUS ICE 155FZ**
OPUS ICE 180FZ

DESCRIPTION

- Features Curved central linear prism controller providing excellent light distribution with minimum glare
- Size 600mmx 600mm
- LOR Downward @ 72%
- Lamp types single 55w TCL \ 80 w TCL Standard High frequency ballast
- Required recess depth of 120mm
- Suitable for both exposed and concealed type ceiling
- Integral emergency battery 3 hour duration \ Self test \ Addressable
- DALI \ DSI \ 1-10 VOLT DC DIMMING OPTIONS



T6
Recessed
Fluorescent Range

CODE: **OPUS SPACE 155FZ**
OPUS SPACE 180FZ

DESCRIPTION

- Features central louvre controller providing excellent light distribution with minimum glare
- Size 600mmx 600mm
- LOR Downward @ 85%
- Lamp types single 55w TCL \ 80 w TCL Standard High frequency ballast
- Required recess depth of 120mm
- Suitable for both exposed and concealed type ceiling
- Integral emergency battery 3 hour duration \ Self test \ Addressable
- DALI \ DSI \ 1-10 VOLT DC DIMMING OPTIONS

