

## CODE: SPH

### DESCRIPTION

A slimline circular luminaire ideal for ceiling/wall mounting. Flame retardant polycarbonate opal diffuser. Available in white, chrome or brass finish body, with a selection of clear, blue, red or green halo filter.

Available Version:

1x28W 2D

1x38W 2D

Emergency version available

### SPECIFICATION

- Metal spun body (white/brass/chrome)
- Polycarbonate opal diffuser
- Semi recessing kit available (optional)

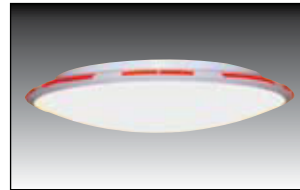
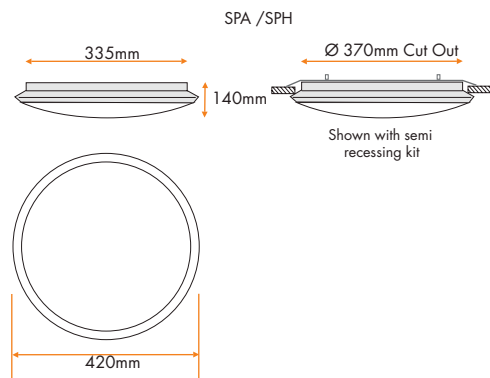

red filter

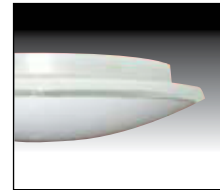

white



blue filter

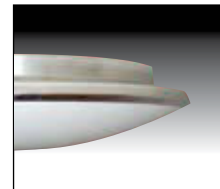

chrome

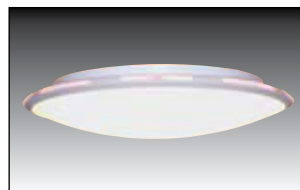

clear filter

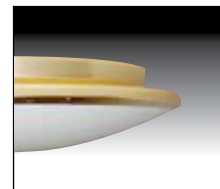

brass

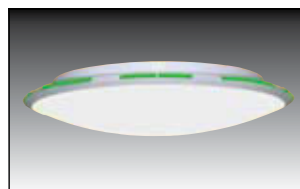

green filter

#### \* Halo filters

C = clear filter

G = green filter

B = blue filter

R = red filter

\* select halo filter

#### High frequency

##### Fully wired

##### Lamps included

T3SPH28DZW0\*L

28W white opal

T3SPH28DZG0\*L

28W brass opal

T3SPH28DZC0\*L

28W chrome opal

T3SPH38DZW0\*L

38W white opal

T3SPH38DZG0\*L

38W brass opal

T3SPH38DZC0\*L

38W chrome opal